

FEATURES

- InGaP HBT Technology
- High Efficiency: 38%
- Low Quiescent Current: 44 mA
- Low Leakage Current in Shutdown Mode: <1 μ A
- Optimized for a 50 Ω System
- Low Profile Surface Mount Package: 1.56mm max
- CDMA 1XRTT Compliant
- CDMA 1xEV-DO Compliant

APPLICATIONS

- PCS CDMA Wireless Handsets
- Dual Band CDMA Wireless Handsets

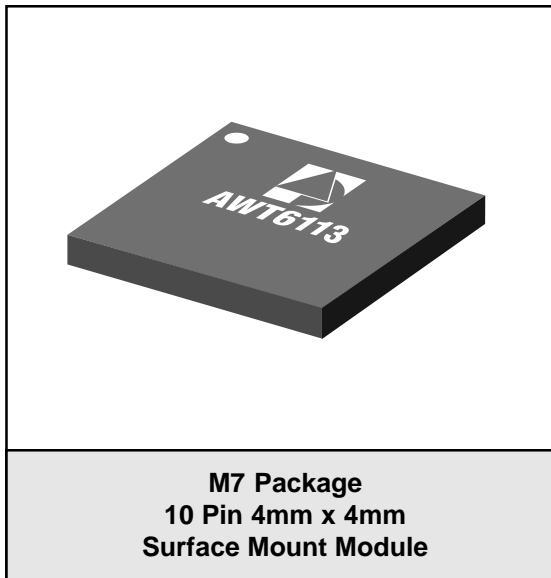

PRODUCT DESCRIPTION

The AWT6113 is a high power, high efficiency amplifier module for PCS/CDMA wireless handset applications. The device is manufactured on an advanced InGaP HBT MMIC technology offering state-of-the-art reliability, temperature stability, and ruggedness. Selectable bias modes that optimize

efficiency for different output power levels, and a shutdown mode with low leakage current, serve to increase handset talk and standby time. The self-contained 4mm x 4mm surface mount package incorporates matching networks optimized for output power, efficiency and linearity in a 50 Ω system.

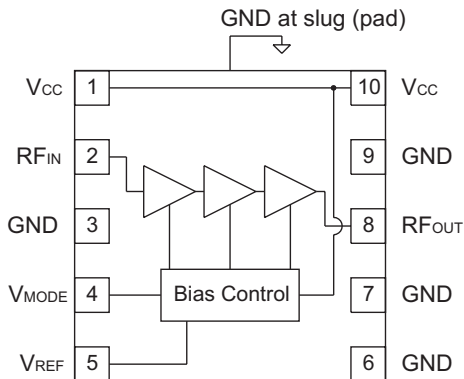

Figure 1: Block Diagram

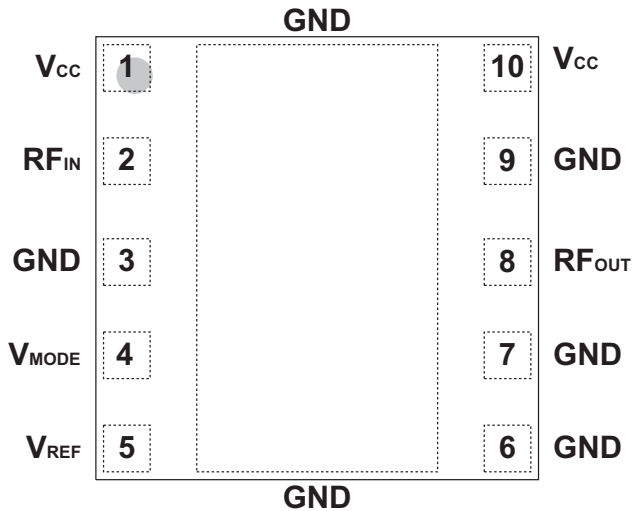

Figure 2: Pinout (X-ray Top View)

Table 1: Pin Description

PIN	NAME	DESCRIPTION
1	V _{CC}	Supply Voltage
2	RF _{IN}	RF Input
3	GND	Ground
4	V _{MODE}	Mode Control Voltage
5	V _{REF}	Reference Voltage
6	GND	Ground
7	GND	Ground
8	RF _{OUT}	RF Output
9	GND	Ground
10	V _{CC}	Supply Voltage

ELECTRICAL CHARACTERISTICS

Table 2: Absolute Minimum and Maximum Ratings

PARAMETER	MIN	MAX	UNIT
Supply Voltage (V_{CC})	0	+5	V
Mode Control Voltage (V_{MODE})	0	+3.5	V
Reference Voltage (V_{REF})	0	+3.5	V
RF Input Power (P_{IN})	-	+10	dBm
Storage Temperature (T_{STG})	-40	+150	°C

Stresses in excess of the absolute ratings may cause permanent damage. Functional operation is not implied under these conditions. Exposure to absolute ratings for extended periods of time may adversely affect reliability.

Table 3: Operating Ranges

PARAMETER	MIN	TYP	MAX	UNIT	COMMENTS
Operating Frequency (f)	1850	-	1910	MHz	
Supply Voltage (V_{CC})	+3.2	+3.4	+4.2	V	
Reference Voltage (V_{REF})	+2.75 0	+2.85 -	+3.1 +0.5	V	PA "on" PA "shut down"
Mode Control Voltage (V_{MODE})	+2.5 0	+2.85 -	+3.1 +0.5	V	Low Bias Mode High Bias Mode
RF Output Power (P_{OUT})	+28.0	-	-	dBm	
Case Temperature (T_C)	-30	-	+85	°C	

The device may be operated safely over these conditions; however, parametric performance is guaranteed only over the conditions defined in the electrical specifications.

Table 4: Electrical Specifications - High Bias Mode
($T_C = +25\text{ }^\circ\text{C}$, $V_{CC} = +3.4\text{ V}$, $V_{REF} = +2.85\text{ V}$, $V_{MODE} = 0\text{ V}$, $P_{OUT} = +28\text{ dBm}$, $50\text{ }\Omega$ system)

PARAMETER	MIN	TYP	MAX	UNIT	COMMENTS
Gain	26	28	30	dB	
Adjacent Channel Power ⁽¹⁾ at ± 1.25 MHz offset Primary Channel BW = 1.23 MHz Adjacent Channel BW = 30 kHz	-	-50	-47	dBc	
Adjacent Channel Power at ± 2.25 MHz offset Primary Channel BW = 1.23 MHz Adjacent Channel BW = 30 kHz	-	-61	-57	dBc	
Power-Added Efficiency ⁽¹⁾	36.5	38	-	%	
Quiescent Current	-	70	90	mA	
Reference Current	-	6	8	mA	through V_{REF} pin
Mode Control Current	-	0	-	mA	through V_{MODE} pin
Leakage Current	-	<1	5	μA	$V_{CC} = +4.2\text{ V}$, $V_{REF} = 0\text{ V}$ $V_{MODE} = 0\text{ V}$
Noise in Receive Band	-	-135	-133	dBm/Hz	1930 MHz to 1990 MHz
Harmonics 2fo 3fo	- - -	-46 -52	-30 -30	dBc	
Input Impedance	-	-	2:1	VSWR	
Spurious Output Level (all spurious outputs)	-	-	-65	dBc	$P_{OUT} \leq +28\text{ dBm}$ In-band load VSWR < 8:1 Out-of-band load VSWR < 8:1 Applies over all voltage and temperature operating ranges
Load mismatch stress with no permanent degradation or failure	8:1	-	-	VSWR	$V_{CC} = +5.0\text{ V}$, $P_{IN} = +5\text{ dBm}$ Applies over full operating temperature range

Notes:

(1) PAE and ACP limit applies to 1880 MHz.

Table 5: Electrical Specifications - Low Bias Mode
 (T_C = +25 °C, V_{CC} = +3.4 V, V_{REF} = +2.85 V, V_{MODE} = +2.85 V, P_{OUT} = +16 dBm, 50 Ω system)

PARAMETER	MIN	TYP	MAX	UNIT	COMMENTS
Gain	23	25	27	dB	
Adjacent Channel Power at ±1.25 MHz offset Primary Channel BW = 1.23 MHz Adjacent Channel BW = 30 kHz	-	-48.5	-46	dBc	
Adjacent Channel Power at ±2.25 MHz offset Primary Channel BW = 1.23 MHz Adjacent Channel BW = 30 kHz	-	-66	-57	dBc	
Power-Added Efficiency	7.5	8.5	-	%	
Quiescent Current	-	44	54	mA	
Reference Current	-	6	8	mA	through V _{REF} pin
Mode Control Current	-	0.3	0.5	mA	through V _{MODE} pin
Leakage Current	-	<1	5	μA	V _{CC} = +4.2 V, V _{REF} = 0 V V _{MODE} = 0 V
Noise in Receive Band	-	-141	-139	dBm/Hz	1930 MHz to 1990 MHz
Harmonics 2fo 3fo	- - -	-48 -52	-30 -30	dBc	
Input Impedance	-	-	2:1	VSWR	

PERFORMANCE DATA

Figure 3: Large Signal Gain vs. Frequency
+3.4 V Supply, High Bias Mode
 (T_C = +25 °C, V_{CC} = +3.4 V, V_{REF} = +2.85 V,
 V_{MODE} = 0 V, P_{OUT} = +28 dBm)

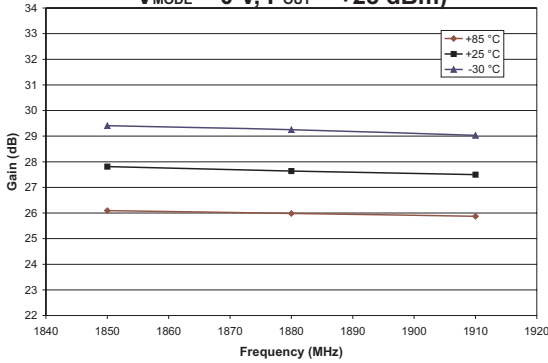

Figure 4: Large Signal Gain vs. Frequency
+3.4 V Supply, Low Bias Mode
 (T_C = +25 °C, V_{CC} = +3.4 V, V_{REF} = +2.85 V,
 V_{MODE} = +2.85 V, P_{OUT} = +16 dBm)

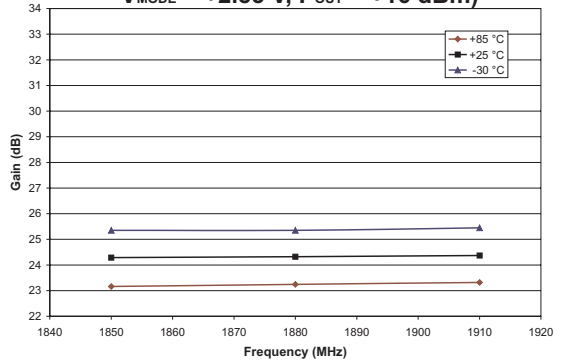

Figure 5: Large Signal Gain vs. Frequency
+4.2 V Supply, High Bias Mode
 (T_C = +25 °C, V_{CC} = +4.2 V, V_{REF} = +2.85 V,
 V_{MODE} = 0 V, P_{OUT} = +28 dBm)

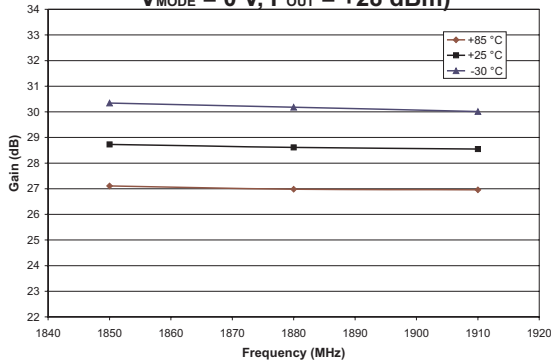

Figure 6: Large Signal Gain vs. Frequency
+4.2 V Supply, Low Bias Mode
 (T_C = +25 °C, V_{CC} = +4.2 V, V_{REF} = +2.85 V,
 V_{MODE} = +2.85 V, P_{OUT} = +16 dBm)

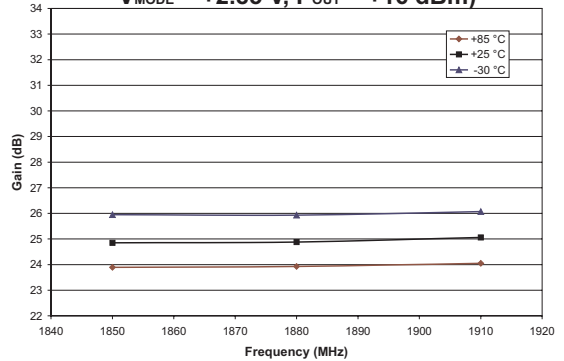

Figure 7: Large Signal Gain vs. Frequency
+3.2 V Supply, High Bias Mode
 (T_C = +25 °C, V_{CC} = +3.2 V, V_{REF} = +2.85 V,
 V_{MODE} = 0 V, P_{OUT} = +28 dBm)

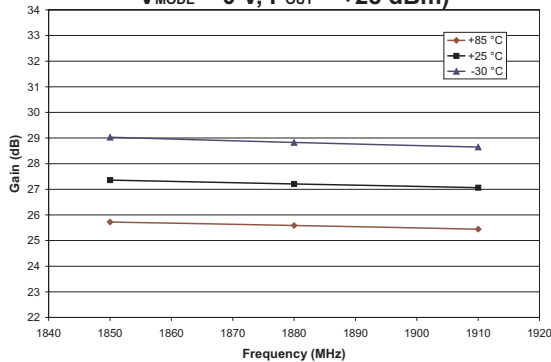

Figure 8: Large Signal Gain vs. Frequency
+3.2 V Supply, Low Bias Mode
 (T_C = +25 °C, V_{CC} = +3.2 V, V_{REF} = +2.85 V,
 V_{MODE} = +2.85 V, P_{OUT} = +16 dBm)

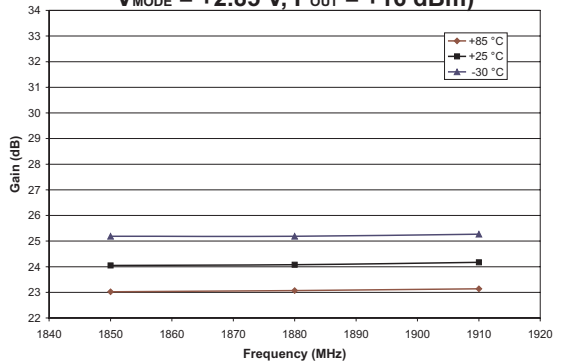

Figure 9: PAE vs. Frequency
+3.4 V Supply, High Bias Mode
 (T_C = +25 °C, V_{CC} = +3.4 V, V_{REF} = +2.85 V,
 V_{MODE} = 0 V, P_{OUT} = +28 dBm)

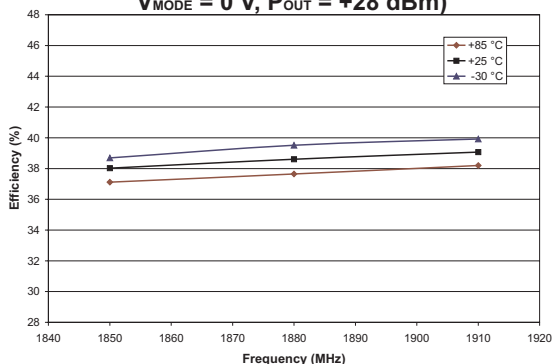

Figure 10: PAE vs. Frequency
+3.4 V Supply, Low Bias Mode
 (T_C = +25 °C, V_{CC} = +3.4 V, V_{REF} = +2.85 V,
 V_{MODE} = +2.85 V, P_{OUT} = +16 dBm)

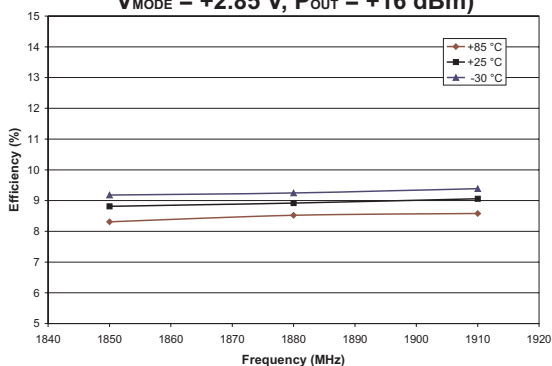

Figure 11: PAE vs. Frequency
+4.2 V Supply, High Bias Mode
 (T_C = +25 °C, V_{CC} = +4.2 V, V_{REF} = +2.85 V,
 V_{MODE} = 0 V, P_{OUT} = +28 dBm)

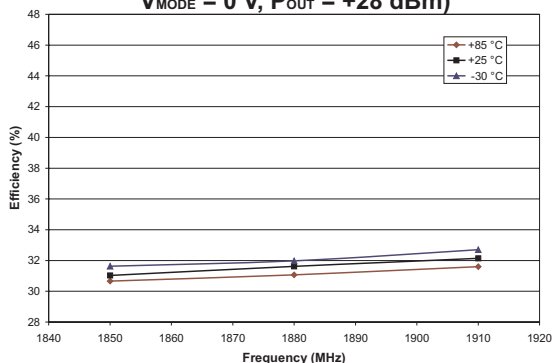

Figure 12: PAE vs. Frequency
+4.2 V Supply, Low Bias Mode
 (T_C = +25 °C, V_{CC} = +4.2 V, V_{REF} = +2.85 V,
 V_{MODE} = +2.85 V, P_{OUT} = +16 dBm)

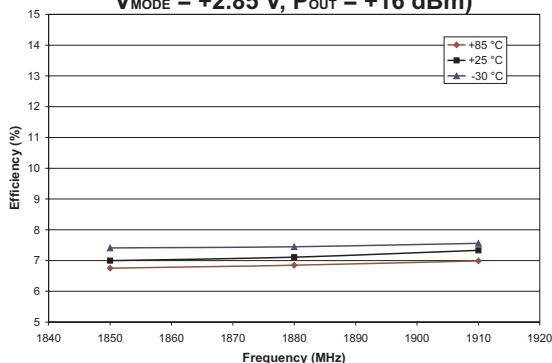

Figure 13: PAE vs. Frequency
+3.2 V Supply, High Bias Mode
 (T_C = +25 °C, V_{CC} = +3.2 V, V_{REF} = +2.85 V,
 V_{MODE} = 0 V, P_{OUT} = +28 dBm)

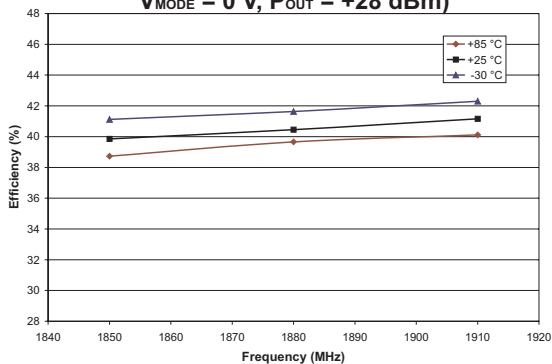

Figure 14: PAE vs. Frequency
+3.2 V Supply, Low Bias Mode
 (T_C = +25 °C, V_{CC} = +3.2 V, V_{REF} = +2.85 V,
 V_{MODE} = +2.85 V, P_{OUT} = +16 dBm)

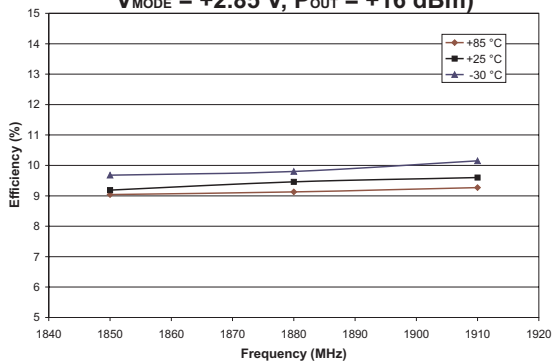

Figure 15: ACP1 vs. Frequency
+3.4 V Supply, High Bias Mode
 (T_C = +25 °C, V_{CC} = +3.4 V, V_{REF} = +2.85 V,
 V_{MODE} = 0 V, Δf_{ACP} = 1.25 MHz, P_{OUT} = +28 dBm)

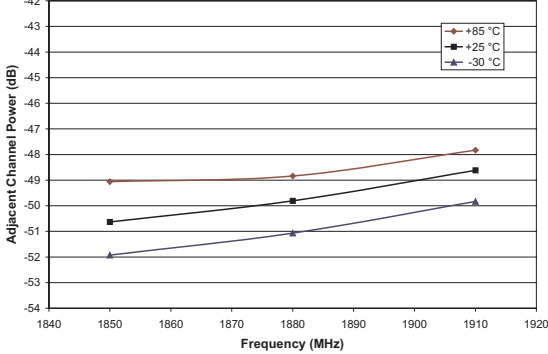

Figure 16: ACP1 vs. Frequency
+3.4 V Supply, Low Bias Mode
 (T_C = +25 °C, V_{CC} = +3.4 V, V_{REF} = +2.85 V,
 V_{MODE} = +2.85 V, Δf_{ACP} = 1.25 MHz, P_{OUT} = +16 dBm)

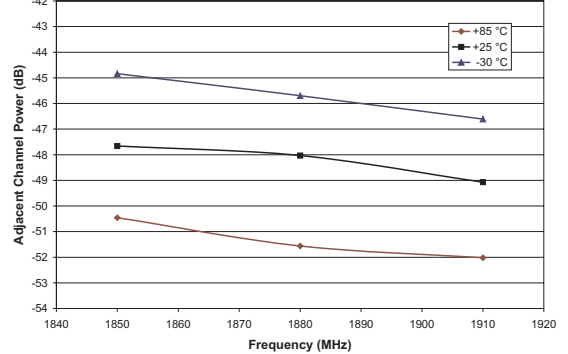

Figure 17: ACP1 vs. Frequency
+4.2 V Supply, High Bias Mode
 (T_C = +25 °C, V_{CC} = +4.2 V, V_{REF} = +2.85 V,
 V_{MODE} = 0 V, Δf_{ACP} = 1.25 MHz, P_{OUT} = +28 dBm)

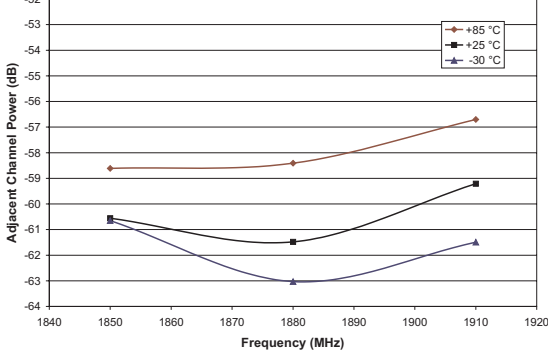

Figure 18: ACP1 vs. Frequency
+4.2 V Supply, Low Bias Mode
 (T_C = +25 °C, V_{CC} = +4.2 V, V_{REF} = +2.85 V,
 V_{MODE} = +2.85 V, Δf_{ACP} = 1.25 MHz, P_{OUT} = +16 dBm)

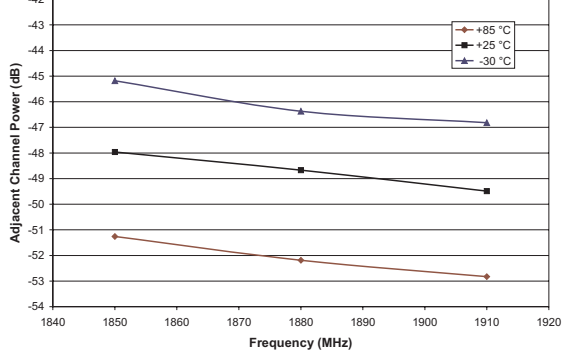

Figure 19: ACP1 vs. Frequency
+3.2 V Supply, High Bias Mode
 (T_C = +25 °C, V_{CC} = +3.2 V, V_{REF} = +2.85 V,
 V_{MODE} = 0 V, Δf_{ACP} = 1.25 MHz, P_{OUT} = +28 dBm)

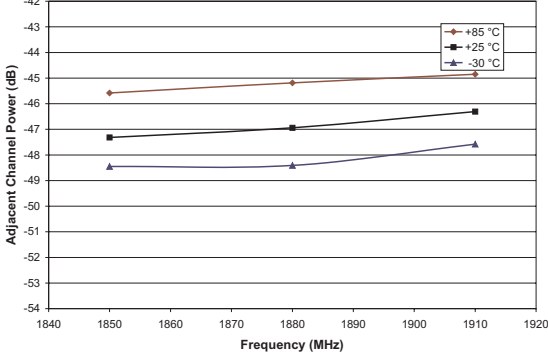

Figure 20: ACP1 vs. Frequency
+3.2 V Supply, Low Bias Mode
 (T_C = +25 °C, V_{CC} = +3.2 V, V_{REF} = +2.85 V,
 V_{MODE} = +2.85 V, Δf_{ACP} = 1.25 MHz, P_{OUT} = +16 dBm)

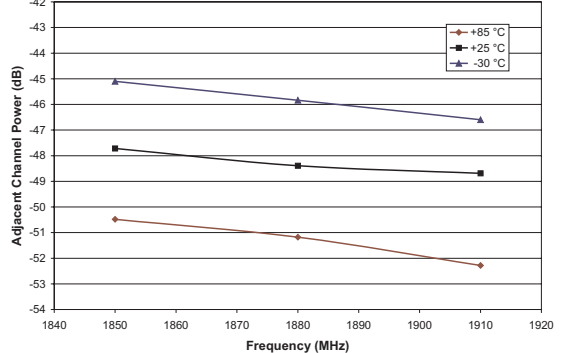

Figure 21: ACP2 vs. Frequency
+3.4 V Supply, High Bias Mode
 (T_C = +25 °C, V_{CC} = +3.4 V, V_{REF} = +2.85 V,
 V_{MODE} = 0 V, Δf_{ACP} = 2.25 MHz, P_{OUT} = +28 dBm)

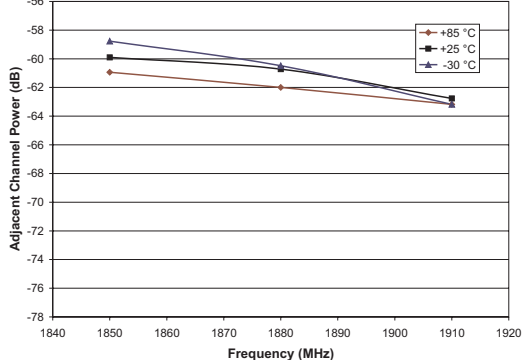

Figure 22: ACP2 vs. Frequency
+3.4 V Supply, Low Bias Mode
 (T_C = +25 °C, V_{CC} = +3.4 V, V_{REF} = +2.85 V,
 V_{MODE} = +2.85 V, Δf_{ACP} = 2.25 MHz, P_{OUT} = +16 dBm)

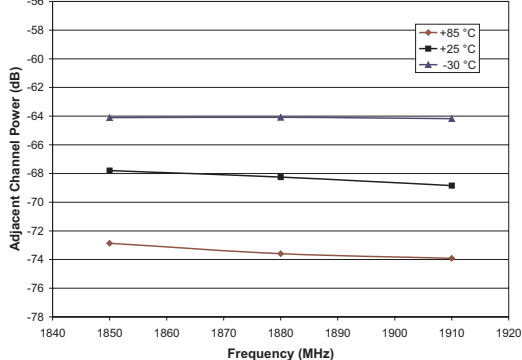

Figure 23: ACP2 vs. Frequency
+4.2 V Supply, High Bias Mode
 (T_C = +25 °C, V_{CC} = +4.2 V, V_{REF} = +2.85 V,
 V_{MODE} = 0 V, Δf_{ACP} = 2.25 MHz, P_{OUT} = +28 dBm)

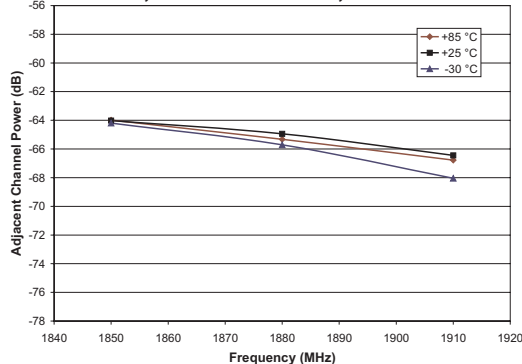

Figure 24: ACP2 vs. Frequency
+4.2 V Supply, Low Bias Mode
 (T_C = +25 °C, V_{CC} = +4.2 V, V_{REF} = +2.85 V,
 V_{MODE} = +2.85 V, Δf_{ACP} = 2.25 MHz, P_{OUT} = +16 dBm)

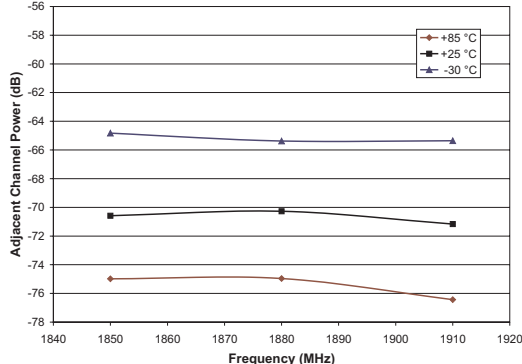

Figure 25: ACP2 vs. Frequency
+3.2 V Supply, High Bias Mode
 (T_C = +25 °C, V_{CC} = +3.2 V, V_{REF} = +2.85 V,
 V_{MODE} = 0 V, Δf_{ACP} = 2.25 MHz, P_{OUT} = +28 dBm)

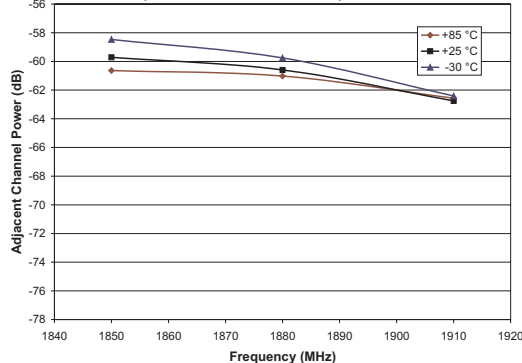
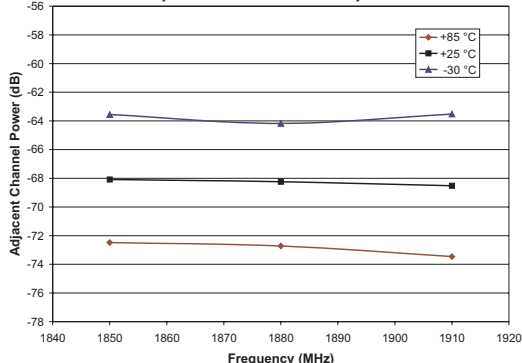

Figure 26: ACP2 vs. Frequency
+3.2 V Supply, Low Bias Mode
 (T_C = +25 °C, V_{CC} = +3.2 V, V_{REF} = +2.85 V,
 V_{MODE} = +2.85 V, Δf_{ACP} = 2.25 MHz, P_{OUT} = +16 dBm)



APPLICATION INFORMATION

To ensure proper performance, refer to all related Application Notes on the ANADIGICS web site: <http://www.anadigics.com>

Shutdown Mode

The power amplifier may be placed in a shutdown mode by applying logic low levels (see Operating Ranges table) to both the V_{REF} and V_{MODE} voltages.

Bias Modes

The power amplifier may be placed in either a Low Bias mode or a High Bias mode by applying the appropriate logic level (see Operating Ranges table) to the V_{MODE} voltage. The Bias Control table lists the recommended modes of operation for various applications.

Table 6: Bias Control

APPLICATION	P _{OUT} LEVELS	BIAS MODE	V _{REF}	V _{MODE}
CDMA - low power	≤+16 dBm	Low	+2.85 V	+2.85 V
CDMA - high power	>+16 dBm	High	+2.85 V	0 V
Shutdown	-	Shutdown	0 V	0 V

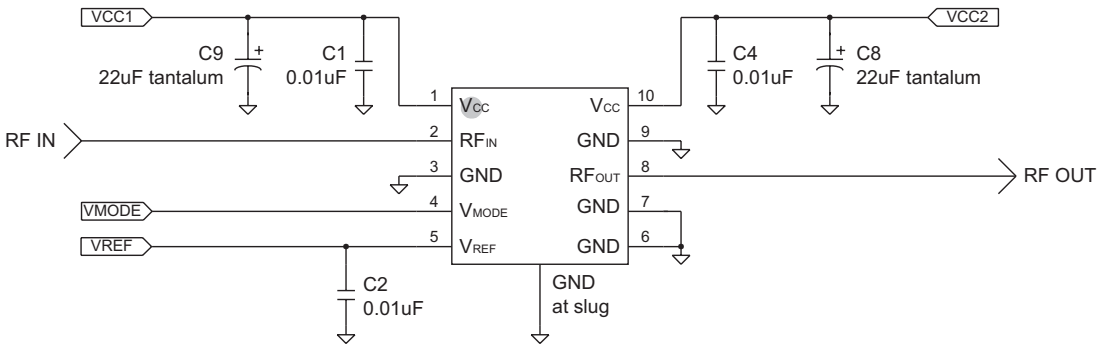
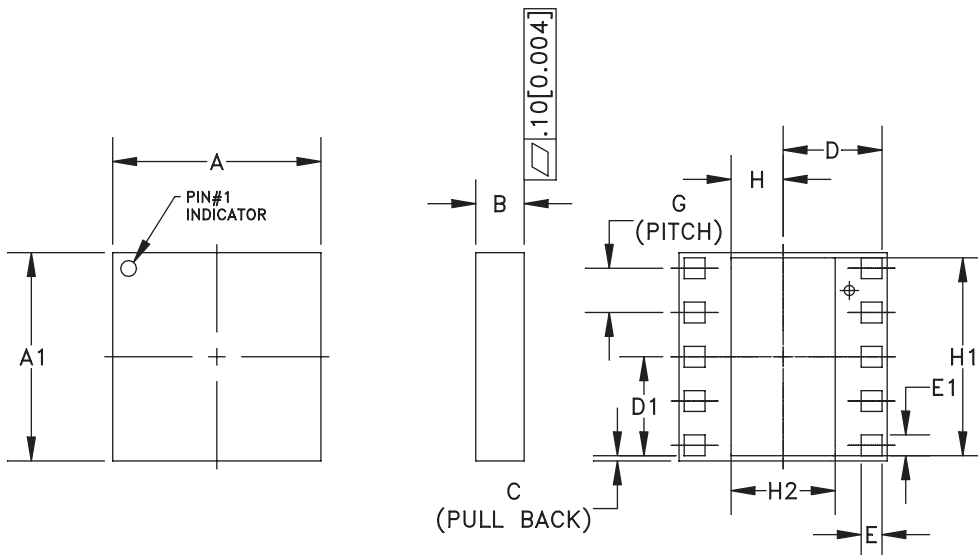

Figure 27: Application Circuit Schematic

PACKAGE OUTLINE



Symbol	MILLIMETERS			INCHES			NOTE
	MIN.	NOM.	MAX.	MIN.	NOM.	MAX.	
A	3.88	4.00	4.12	0.152	0.157	0.162	-
A1	3.88	4.00	4.12	0.152	0.157	0.162	-
B	1.26	1.41	1.56	0.049	0.055	0.061	-
C	-	0.10	-	-	0.004	-	-
D	-	1.90	-	-	0.075	-	-
D1	-	1.90	-	-	0.075	-	-
E	0.35	0.40	0.45	0.013	0.015	0.017	-
E1	0.35	0.40	0.45	0.013	0.015	0.017	-
G	0.85 BSC			0.033 BSC			-
H	-	1.00	-	-	0.039	-	-
H1	-	3.80	-	-	0.149	-	-
H2	-	2.00	-	-	0.078	-	-

NOTES:

1. CONTROLLING DIMENSIONS: MILLIMETERS
2. UNLESS SPECIFIED TOLERANCE=±0.076[0.003].

Figure 28: M7 Package Outline - 10 Pin 4mm x 4mm Surface Mount Module

TOP BRAND

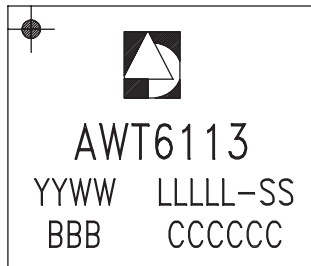

NOTES:

1. ANADIGICS LOGO SIZE: X=0.040±0.010 Y=0.048±0.010
2. PART # AWT6113
3. YEAR AND WORK WEEK: YYWW: YY = YEAR, WW = WORK WEEK
4. LOT - WAFER I.D.: LLLLL-SS = WAFER/LOT I.D.
5. PIN 1 INDICATOR: MOLD NOTCH -or- INK DOT
6. BOM # BBB
7. COUNTRY CODE: CCCCC
8. TYPE : ELITE
SIZE : AS LARGE AS POSSIBLE
WHITE or SILVER

Figure 29: Branding Specification

COMPONENT PACKAGING

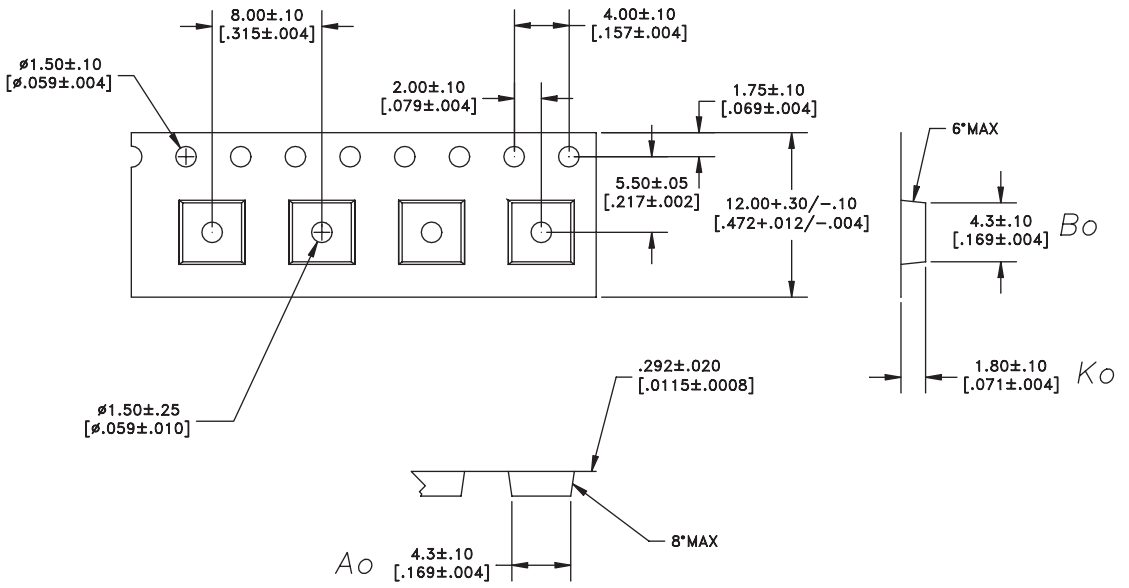

DIMENSIONS ARE IN MILLIMETERS [INCHES]
STANDARD TOLERANCES

Figure 30: Tape & Reel Packaging

Table 7: Tape & Reel Dimensions

PACKAGE TYPE	TAPE WIDTH	POCKET PITCH	REEL CAPACITY	MAX REEL DIA
4mm X 4mm	12mm	8mm	2500	13"

NOTES

AWT6113

NOTES

NOTES

ORDERING INFORMATION

ORDER NUMBER	TEMPERATURE RANGE	PACKAGE DESCRIPTION	COMPONENT PACKAGING
AWT6113M7P8	-30 °C to +110 °C	10 Pin 4mm x 4mm Surface Mount Module	Tape and Reel, 2500 pieces per Reel

**ANADIGICS, Inc.**

141 Mount Bethel Road
Warren, New Jersey 07059, U.S.A.

Tel: +1 (908) 668-5000

Fax: +1 (908) 668-5132

URL: <http://www.anadigics.com>

E-mail: Mktg@anadigics.com

IMPORTANT NOTICE

ANADIGICS, Inc. reserves the right to make changes to its products or to discontinue any product at any time without notice. The product specifications contained in Advanced Product Information sheets and Preliminary Data Sheets are subject to change prior to a product's formal introduction. Information in Data Sheets have been carefully checked and are assumed to be reliable; however, ANADIGICS assumes no responsibilities for inaccuracies. ANADIGICS strongly urges customers to verify that the information they are using is current before placing orders.

WARNING

ANADIGICS products are not intended for use in life support appliances, devices or systems. Use of an ANADIGICS product in any such application without written consent is prohibited.